

164 Series Datasheet

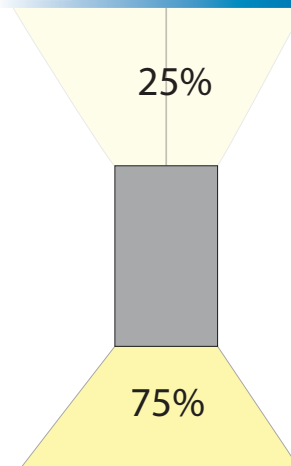

Key Features

- ▶ Extruded direct/indirect linear profile luminaire
- ▶ Typical percentage output ratio 75 : 25
- ▶ Finished in RAL 9006 grey as standard
- ▶ Available in 4 standard lengths
- ▶ Delivering approx. 3000lm per meter as standard
- ▶ Coloured matched, injection moulded end caps
- ▶ TPa opal lens for feature, general and visual areas
- ▶ Low Glare prismatic lens available for office and LG7 compliance
- ▶ Tridonic low energy LED and driver system
- ▶ Life up to 60,000 hours L80/F10
- ▶ Efficacy up to 130 Llm/Tcw
- ▶ Manufactured in the U.K.

Technical Drawing

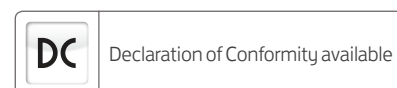
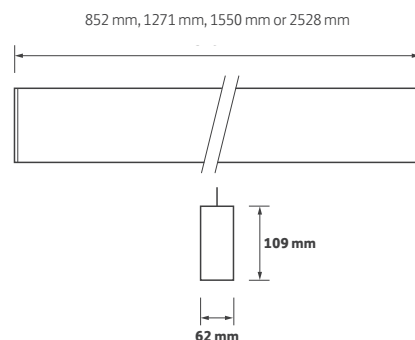

Ordering Information

Length	Colour	Total	Model Ref.	Total	Total
		Output (Llm) Std		Output (Llm) /LO	Output (Llm) /HO
850 mm	830	2450	164.001	1800	3700
850 mm	840	2450	164.002	1800	3700
1.2 mtr	830	3650	164.003	2675	5550
1.2 mtr	840	3650	164.004	2675	5550
1.5 mtr	830	4750	164.005	3475	7150
1.5 mtr	840	4750	164.006	3475	7150
2.5 mtr	830	7300	164.007	5375	11075
2.5 mtr	840	7300	164.008	5375	11075

Options

Please select from the options below.

White Body	/WH
Black Body	/BK
Lower output	/LO
Higher output	/HO
Low glare prismatic lens for LG7 compliance	/LG
SwitchDIM, DALI or DSI	/ECO
EM conversion	/EMI

164 Series Options and Accessories



Options

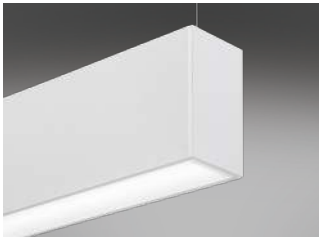

/WH
White Body

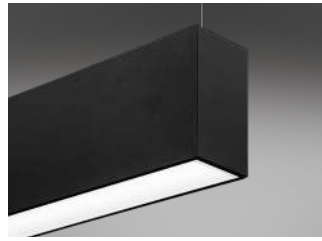

/BK
Black Body

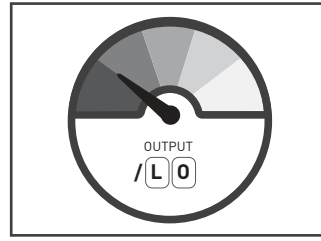

/LO
Lower output

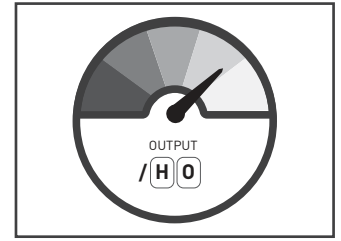

/HO
Higher output

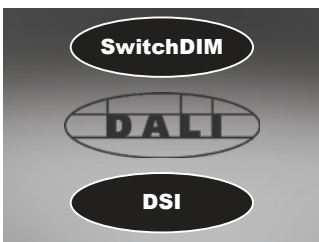

/ECO
SwitchDIM, DALI or DSI

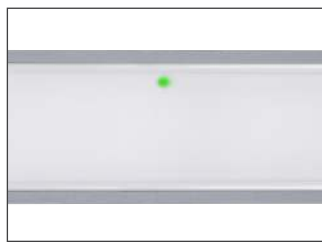

/EMI
EM conversion

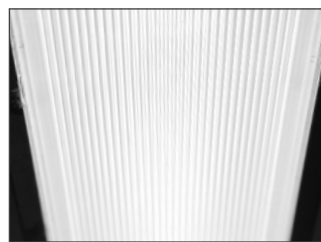

/LG
Low glare prismatic lens

Also Available



BU.164/180
180° Butt joint bracket



BU.164/90
90° Butt joint bracket



Product variations
Other colours and specifications
available on request

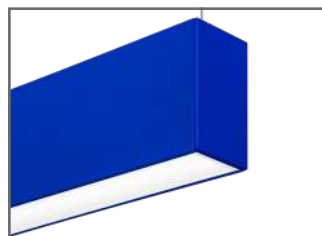

Product variations
Custom body colours

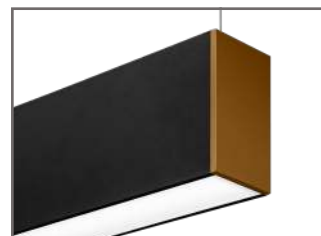

Product variations
Custom colours



PT001
Diffuser removal tool