

AL-LR5535A

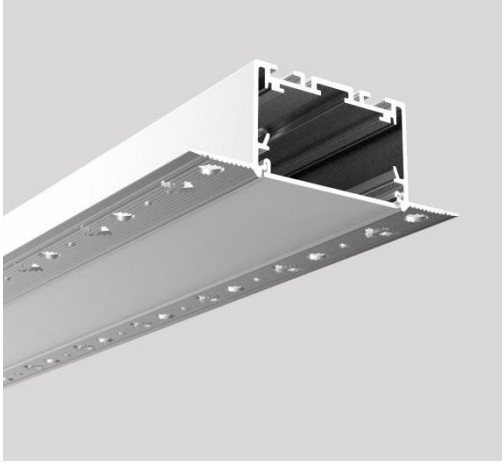

Features

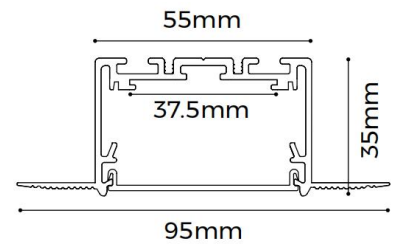



- Several optional diffuser: general PC diffuser, flexible PC diffuser, flexible anti-glare diffuser, black diffuser, aluminium blind diffuser
- 50mm large luminous surface, rimless recessed design, integrated into architecture.
- Leakage proof shield design, perfect details.
- AL6063-T5 aluminum profile with high-quality surface treatment, black, white and silver are optional.
- Multiple optional connectors: 180 ° direct connection, L type, T type, X type

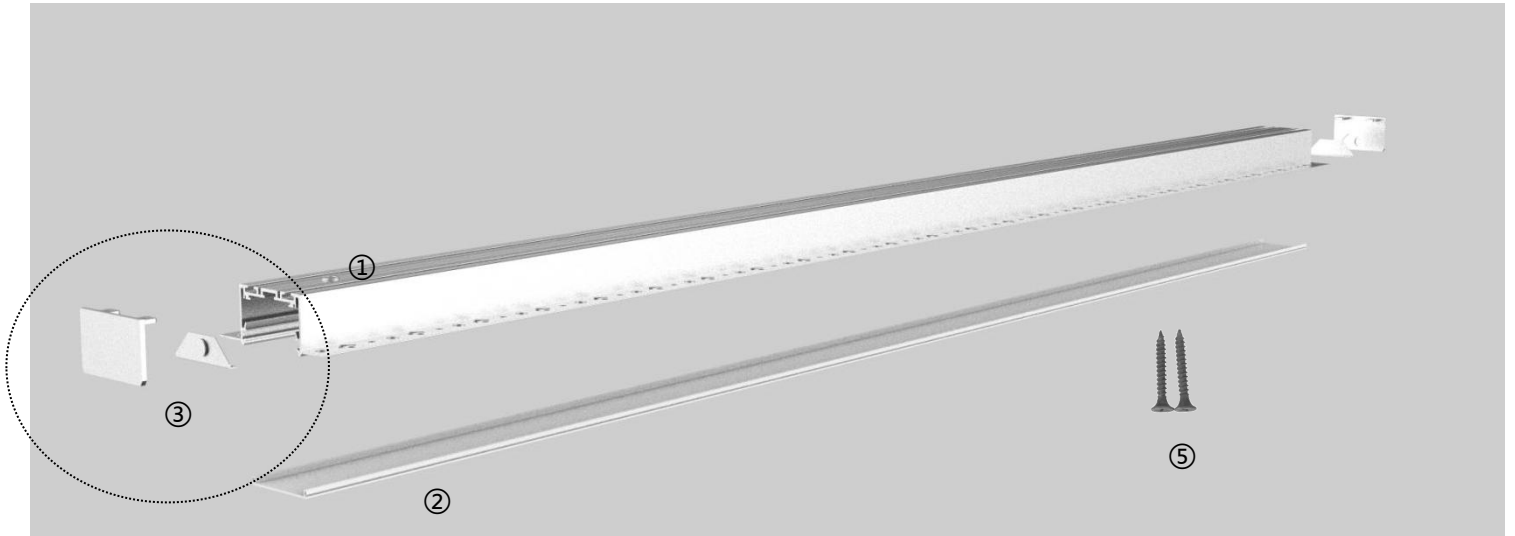

Details



Standard Configuration

Picture	Item	Parameter	Model
	①Profile	Profile weight: 2.52kg/2.5m Size: L2500*W95*H35mm Material: AL6063-T5 Surface processing: Anodizing	AL-LR5535A
	②Cover	Type: Frosted diffuser Material: PC Light transmittance: 75% Size: L2500*W48.8*H5.6mm PC Feature: The diffuser will extend (shrink) 0.8mm/m when the temperature raises (drops) 10°C.	/
	③End cap	Size: L55*W35*H22mm	AL-EC-LR5535A
	⑤Install screw	Size: M3.5*40mm	AL-CL-01

Optical Parameter

D8280-24V-34mm light source, frosted diffuser

LUMINOUS INTENSITY DISTRIBUTION DIAGRAM

